

B A R B A R O

ASV, Barbaro, c. 199

da S. Vidal

FRANCESCO dott K proc — ZACCARIA K proc

CANDIAN — ALMORO'

ZACCARIA — DANIEL

1421 (sua) ha di Vidal D. Maria

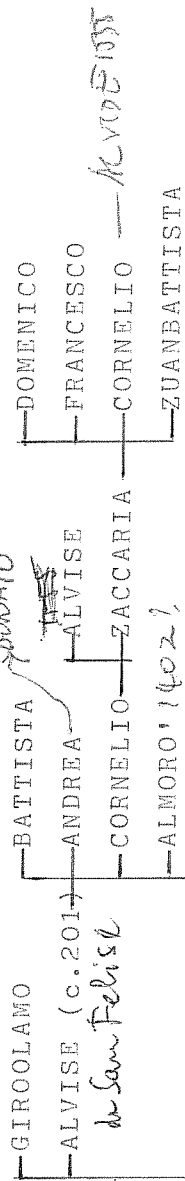

DANIEL — ZACCARIA — ALMORO' (c. 202) !

(c. 200)

DANIEL

ALVISE

CANDIAN — ZACCARIA

MATHIO

ZUANE

FRANCESCO — DANIEL dott K

ANTONIO proc

ALMORO'

ALVISE

FRANCESCO

with didiana va a San Vidal

prima spartizione fra i c. 200 nel 1428

1421  
ALMORO'  
ALVISE

B A R B A R O

dal testo originale dell'ASV

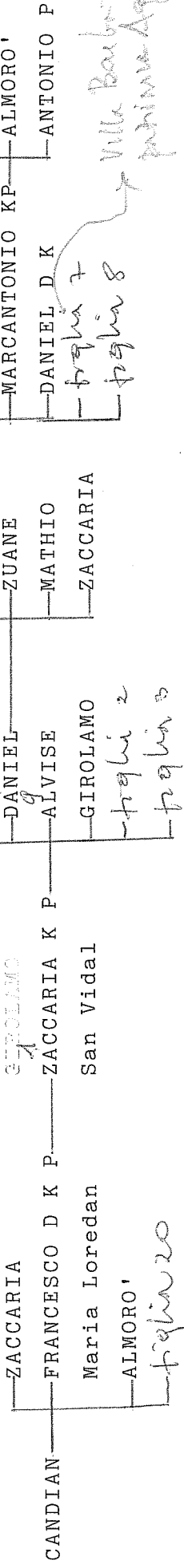

ZACCARIA

- CANDIAN
- ALVISE
- DANIEL
- ALMORO'

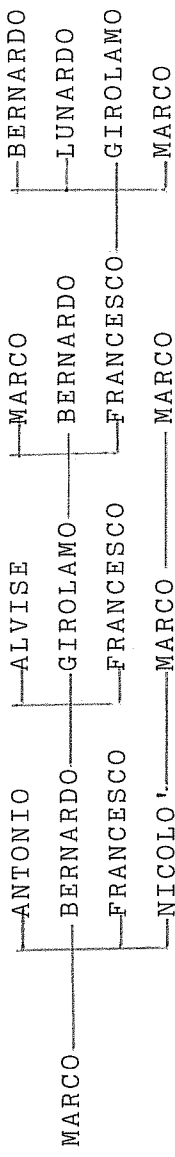

Autore del libro delle Genealogie

GIACOMO

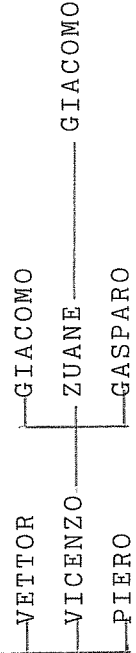

B A R B A R O

dal testo originale dell'A S V

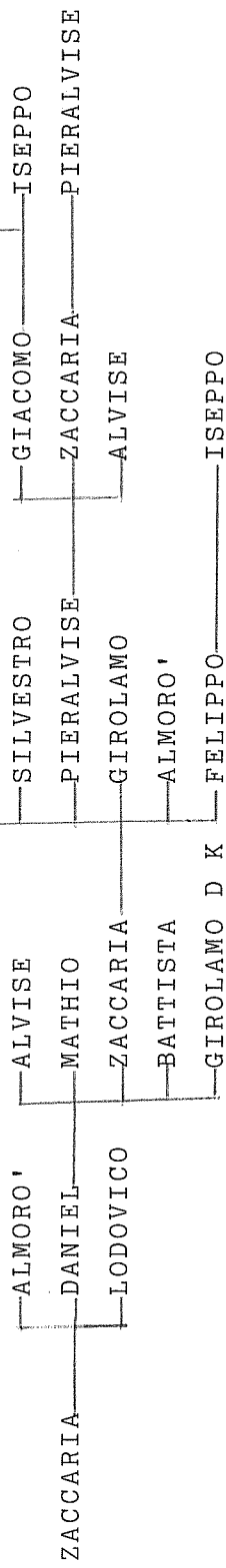

~~tooboo~~  
~~tooboo~~

Cojich an

domina

fachens DKP  
1449 Marten Gredom

1449 chava den chamin  
Rauani & P

→ da Lau Udal

almuro

almuro DK

almuro almuro

gredom

fachens  
1504  
drome Pisoni

almuro  
fuch

almuro

almuro

almuro  
1741  
cor mwa Gomer  
p. drome

almuro  
1741  
Gomer  
p. drome

almuro  
1741  
Gomer  
p. drome

almuro DK

fachens

almuro

almuro P  
Lama Pisoni

almuro

almuro  
1775  
fachens  
Lama Pisoni

almuro  
1775  
fachens  
Lama Pisoni

almuro  
1769  
fachens  
Lama Pisoni

almuro  
1760  
fachens  
Lama Pisoni

almuro  
1775  
fachens  
Lama Pisoni

almuro  
1732  
fachens  
Lama Pisoni

Carbon  
1414

burning  
1446

burning  
1535

burning  
1511

burning  
1514 & 1517

burning  
1485

burning  
1515

burning  
1517

burning  
1517

burning  
1517

burning  
1517

burning  
1517

burning  
1517

burning  
1517

burning  
1517

burning  
1511

burning  
1535

burning  
1517

burning  
1517

burning  
1517

burning  
1517

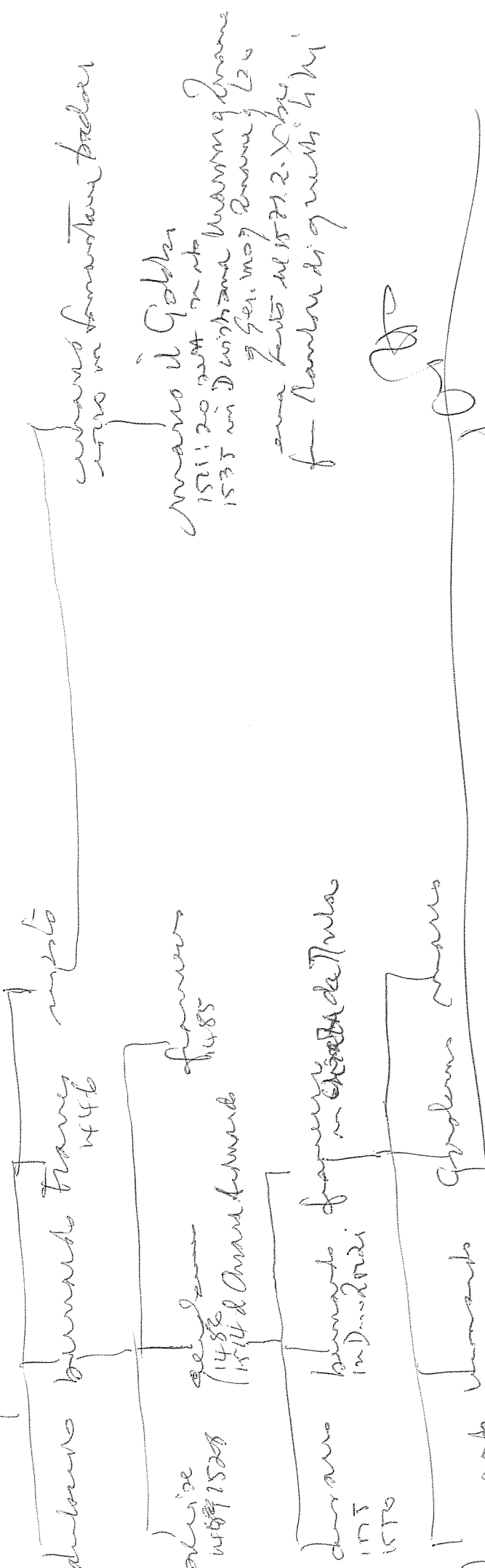

burning  
1517

burning  
1517

burning  
1517

B A R B A R O

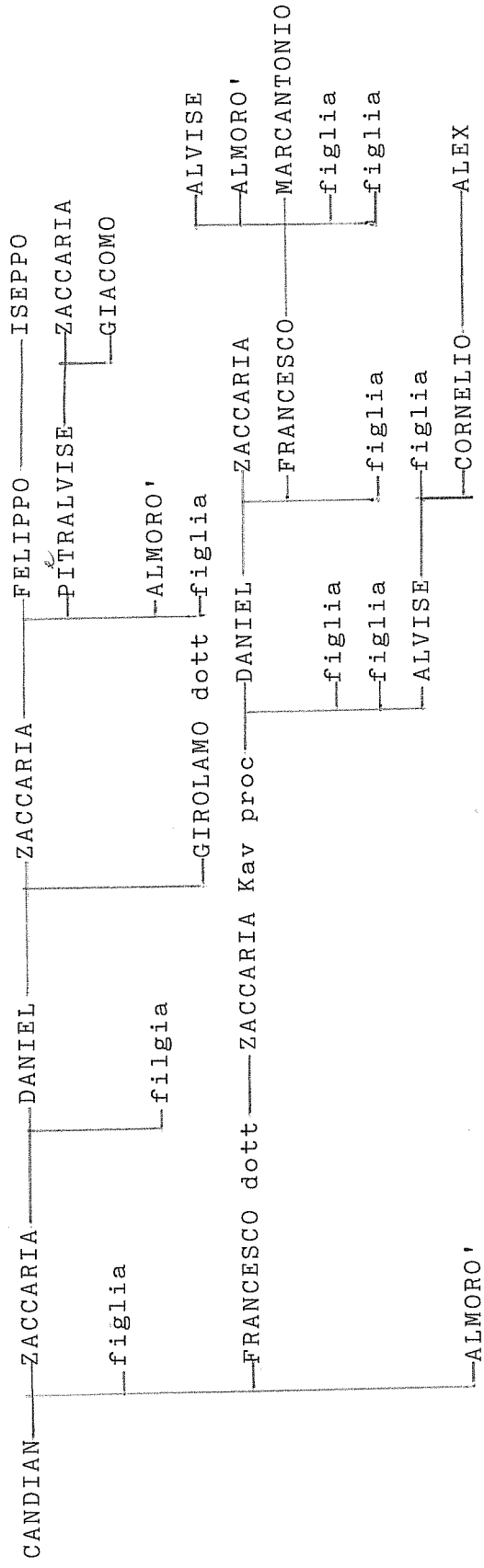
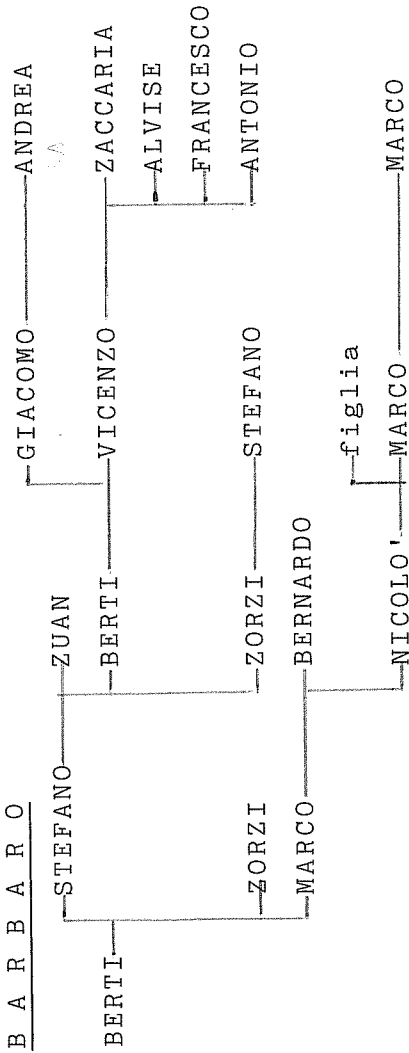

97510